

# Hose drop system 5S and 5SL

Flexible hose drop system with weight loaded 5-orifice tip for late liquid fertilizer application.

## Advantages

- No scorching, because weight-loaded 5-orifice tip is submerged in crop
- 5-orifice tip distributes the liquid fertilizer uniformly in the crop with 0.5 m hose spacing
- In comparison with 0.25 m hose drop system, lower boom loading when pulling through the crop
- Compliance with transport width by ideal adaption of the hose when boom is folded
- Extension as spacer with hose attachment prevents paint damage to the sprayer when folded in
- Including bayonet cap system MULTIJET (incl. gasket) as standard
- Selection of l/ha rate by nozzle plates

 **Tube spacing**  
0.5 m  
(depending on boom)

 **ISO dosing orifice**  
– 5S:  
02 and 03 mm  
– 5SL:  
04, 05 and 06 mm

 **Spray angle**  
160°

 **Pressure range**  
1 – 5 bar

## Application area

 Liquid fertilizer  
– 5S:  
50 – 300 l/ha UAN  
– 5SL:  
180 – 550 l/ha UAN

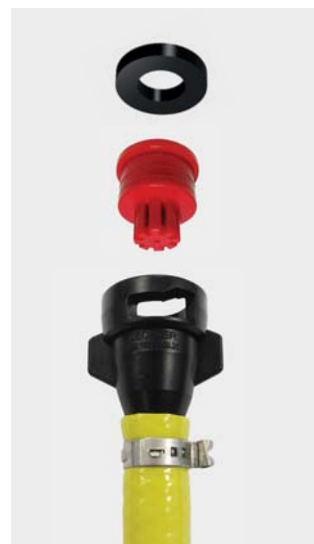
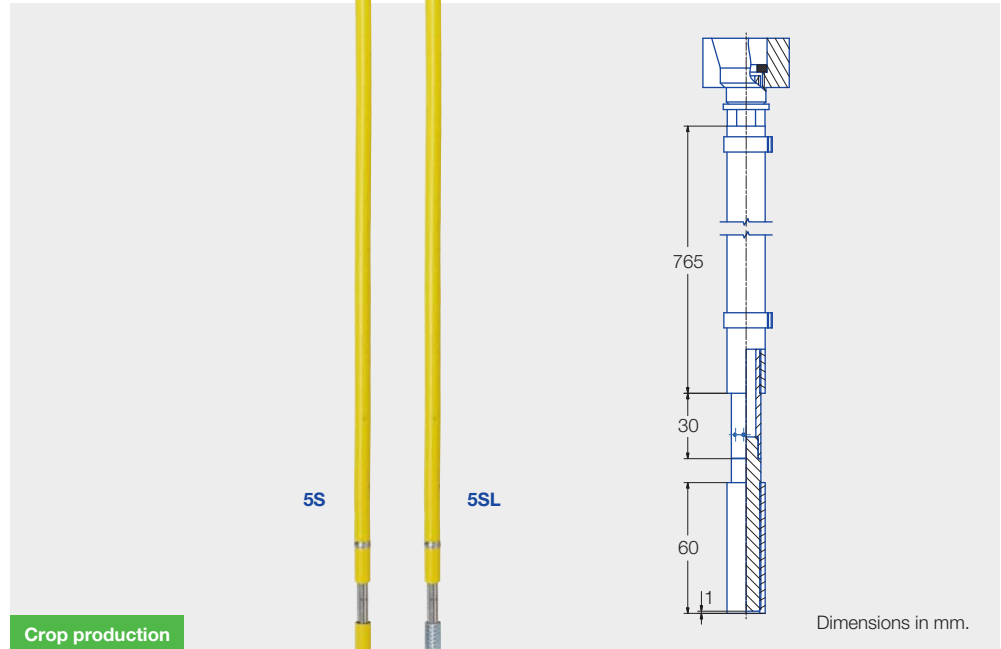

## Assembly instruction

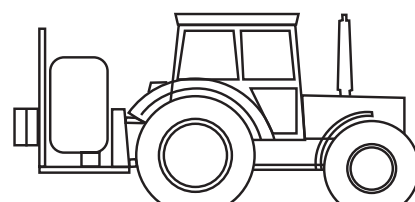

Fit hose drop system 5S and 5SL facing forwards in driving direction when assembling on the field spray boom. When the system floats up slightly, the nozzle will then spray directly into the crop.





**Direction of travel = spraying direction**

Lead hose drop 5S and 5SL  
5–10 cm above the soil.

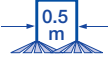
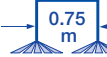



# Spray table for hose drop system 5S and 5SL

	  Ø mm		l/min		UAN l/ha 					UAN l/ha 				
			Water	UAN	5.0 km/h	6.0 km/h	7.0 km/h	8.0 km/h	10.0 km/h	5.0 km/h	6.0 km/h	7.0 km/h	8.0 km/h	10.0 km/h
5S	02	1	0.46	0.41	98	81	70	61	49	65	54	46	41	33
		2	0.65	0.57	138	115	98	86	69	92	77	66	57	46
		3	0.80	0.71	170	141	121	106	85	113	94	81	71	57
		4	0.92	0.81	195	163	139	122	98	130	108	93	81	65
		5	1.03	0.91	218	182	156	137	109	146	121	104	91	73
	03	1	0.69	0.61	146	122	105	91	73	98	81	70	61	49
		2	0.97	0.86	206	171	147	129	103	137	114	98	86	69
		3	1.19	1.05	252	210	180	158	126	168	140	120	105	84
		4	1.37	1.21	291	242	208	182	145	194	161	138	121	97
		5	1.54	1.36	327	272	233	204	163	218	181	156	136	109
5SL	04	1	0.91	0.80	193	161	138	121	97	129	107	92	80	64
		2	1.29	1.14	274	228	195	171	137	182	152	130	114	91
		3	1.58	1.40	335	279	239	209	168	223	186	160	140	112
		4	1.82	1.61	386	322	276	241	193	257	214	184	161	129
		5	2.04	1.80	433	361	309	270	216	288	240	206	180	144
	05	1	1.14	1.01	242	202	173	151	121	161	134	115	101	81
		2	1.61	1.42	342	285	244	213	171	228	190	163	142	114
		3	1.97	1.74	418	348	299	261	209	279	232	199	174	139
		4	2.27	2.01	482	401	344	301	241	321	268	229	201	161
		5	2.54	2.25	539	449	385	337	269	359	299	257	225	180
	06	1	1.36	1.20	288	240	206	180	144	192	160	137	120	96
		2	1.93	1.71	409	341	292	256	205	273	227	195	171	136
		3	2.36	2.09	501	417	358	313	250	334	278	238	209	167
		4	2.73	2.41	579	483	414	362	290	386	322	276	241	193
		5	3.05	2.70	647	539	462	404	324	431	359	308	270	216

Description	Photo	Ordering no.
<b>Hose drop system 5S</b>		092.173.00
Dosing orifices		
ISO 02 (formerly: 1,0/39)*		600.500.56.02.40.0
ISO 03 (formerly: 1,2/48)*		600.500.56.03.40.0
<b>Hose drop system 5SL</b>		092.173.00.01.00
Dosing orifices		
ISO 04 (formerly: 1,5/59)*		600.500.56.04.40.0
ISO 05		600.500.56.05.40.0
ISO 06 (formerly: 1,8/72)*		600.500.56.06.40.0

\* Until 2019 stainless steel dosage orifices. Liter per hectare rates see FL nozzle page 73.

## Accessories

Securing clip		092.164.56.00.10.06
Special 4 mm gasket		095.015.6C.02.85.0
Adaptor for system Lechler TWISTLOC		092.163.56.00.22.1
Adaptor for system Rau		092.163.56.00.21.0
Adapter for system Hardi		092.163.56.00.20.1

## Online nozzle calculator



Apple



Android

- Prior to each spraying season verify the table data by gauging the flow rates
- Make sure that in all hoses the same dosing orifice are fitted
- Lateral hose spacing 0.5 m
- Spray pressure at dosing orifice (gauged with a diaphragm valve)
- The stated liter-per-hectare rates apply to UAN (28/1.29 kg/l)



Relocation kit nozzle holder for variable row width adaption.  
More information see page 113.  
Ordering no. 092.174.00.00.00.0



More detailed information is available in Lechler brochure for application of liquid fertilizer as well as [www.lechler-agri.com](http://www.lechler-agri.com)

